



# MAGNETIC DRIVE PUMPS

## Magnet Kreisel Pumpen



# PRICE<sup>®</sup> PUMP CO.

AMERICA'S MOST VERSATILE LINE OF CENTRIFUGAL PUMPS

THINK QUALITY...THINK DELIVERY...THINK PRICE<sup>®</sup>

Distributor: VIPTech GmbH

Web: [www.price-pumpen.de](http://www.price-pumpen.de)

Mail: [anfrage@price-pumpen.de](mailto:anfrage@price-pumpen.de)

# Seal-less Design

Price® Pump magnetically driven, seal-less pumps provide a leak-proof solution to today's most challenging process applications. Top quality materials along with our innovative design features result in a pump that delivers excellent performance and durability.

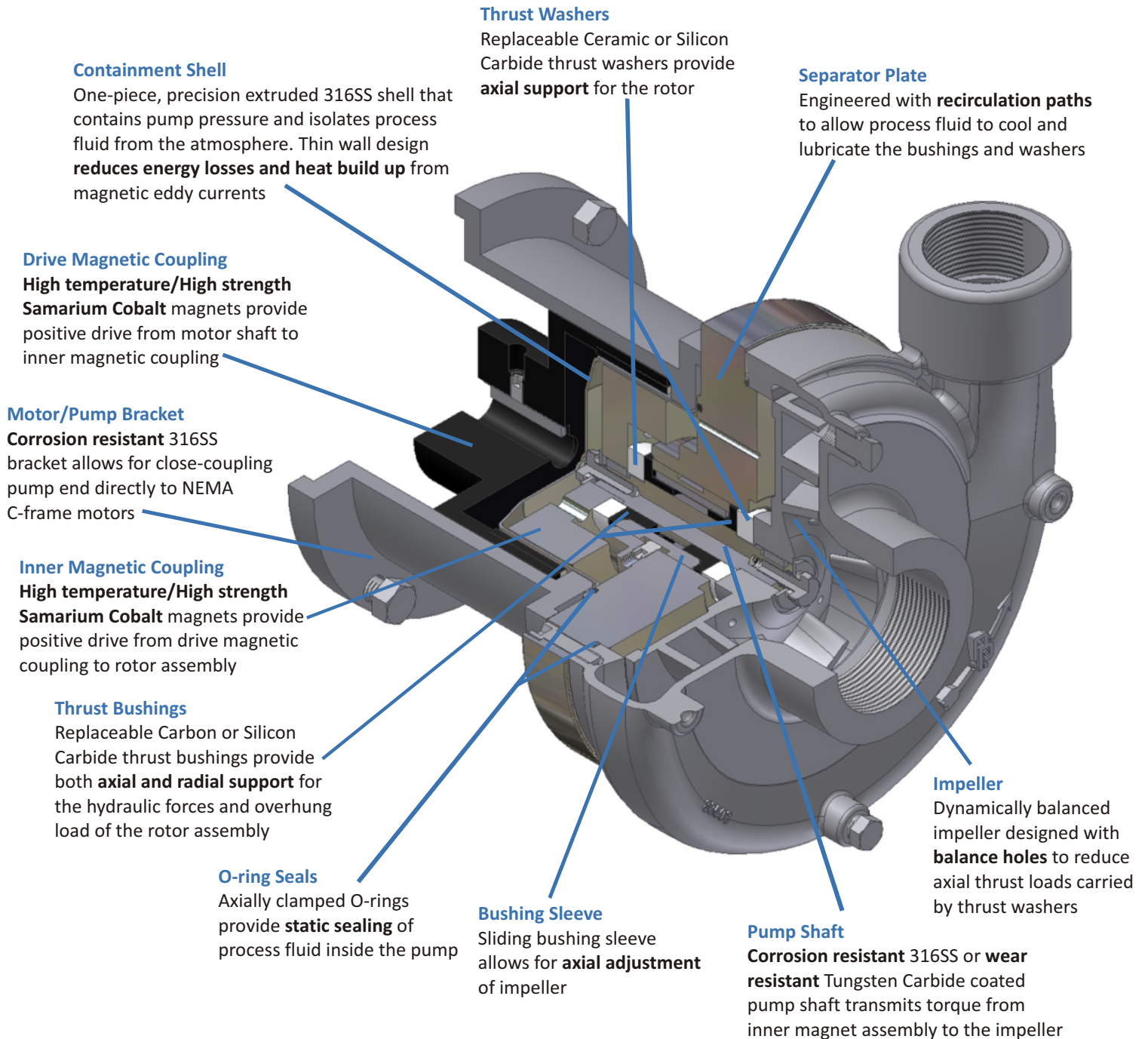

## Advantages

- Zero leakage** - Prevents loss of hazardous and/or expensive process fluids due to total product containment
- 100% Emission free** - Provides a safer, cleaner working environment
- Sealless design** - Elimination of the rotating mechanical seal rids the user of potential problems with mechanical seals
- Low maintenance** - Reliable pump operation reduces down time and keeps maintenance costs at a minimum

## Applications

Refrigeration \* Semi-Conductor \* Chemical Processes \* Biodiesel Production \* Water Treatment \* Pulp and Paper  
 Pharmaceutical \* Toxic Fluids \* Scrubber Applications \* Galvanic Processes \* Automotive \* Vapor Degreasers

## Design Features

**Magnetic couplings** - Special grade of high temperature/high strength Samarium Cobalt magnets used in coupling assemblies result in a highly efficient coupling that can be used for extreme temperature applications

**Bushings/washers** - Interchangeable front and rear bushings and washers are designed to maximize thrust, temperature and abrasive handling capabilities. Materials available are Carbon, Ceramic and Silicon Carbide

**Hex shaft design** - Higher torque pump models use shafts with hex drive ends to eliminate common shaft/key failures. Shafts are also available with a Tungsten Carbide coating for abrasive applications

**Universal bracket** - One standardized investment cast 316SS bracket is used on all pump models and mounts to NEMA C-Face motors

## Performance

Twelve different pump models available to meet wide range of performance requirements

- Capacities to 400 GPM
- Heads to 320 Feet
- Temperatures from Cryogenic to 350F
- Working pressures to 300 psi
- Motors up to 15 HP

Materials of Construction	
Part	Material
Volute	316 Stainless Steel
Impeller	316 Stainless Steel
Motor/Pump Bracket	316 Stainless Steel
Separator Plate	316 Stainless Steel
Bushing Sleeve	316 Stainless Steel
Containment Shell	316 Stainless Steel
Fasteners	316 Stainless Steel
Magnetic Couplings	Samarium Cobalt/316 Stainless Steel
Thrust Washers	Ceramic (STD), Silicon Carbide
Thrust Bushings	Carbon (STD), Silicon Carbide
Pump Shaft	316 Stainless Steel (STD), Tungsten Carbide Coated
O-Rings	Viton (STD), Teflon, Buna, Neoprene Kalrez, EPR, Fluoro-Silicon

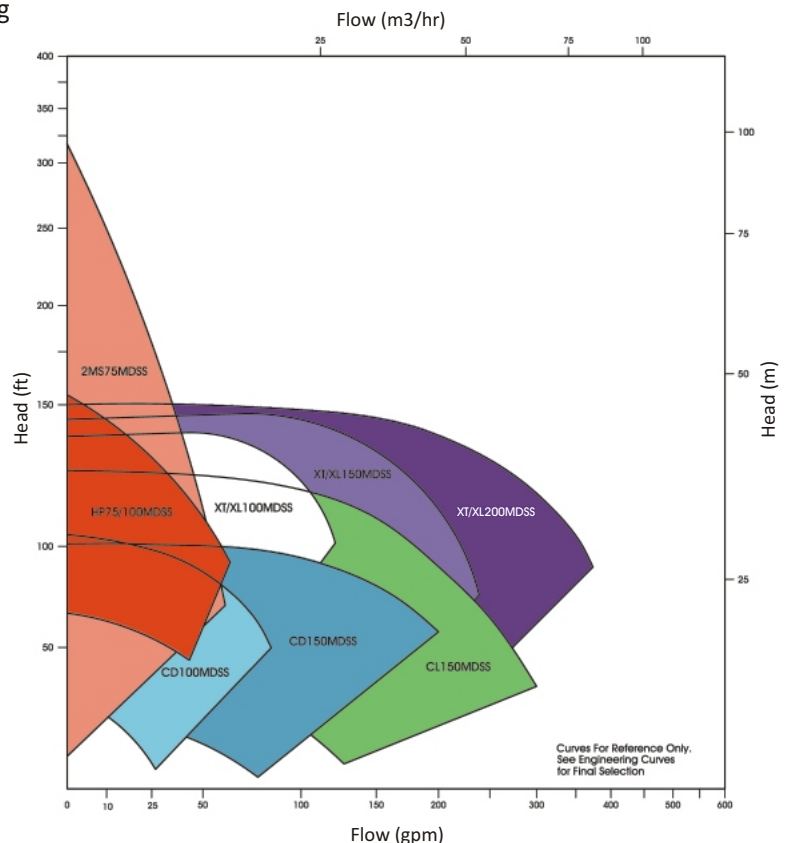

# Type MS-MD

 Flows to 60 GPM / Heads to 320 Feet

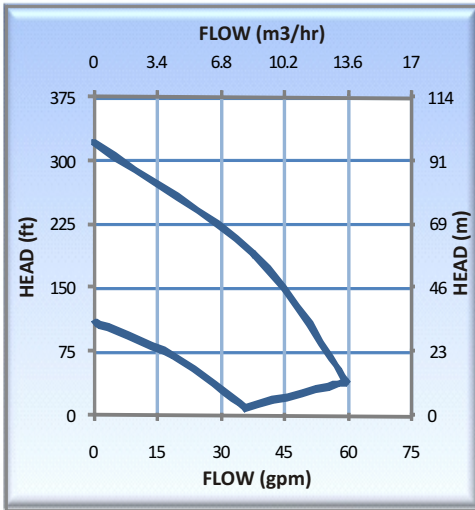

## MODELS

2MS75MDSS: 3/4" x 1" x 6"

## FEATURES

- Innovative 2-Stage pump
- Closed Impeller
- Maximum impeller diameter: 5.98"



# Type HP-MD

 Flows to 65 GPM / Heads to 160 Feet

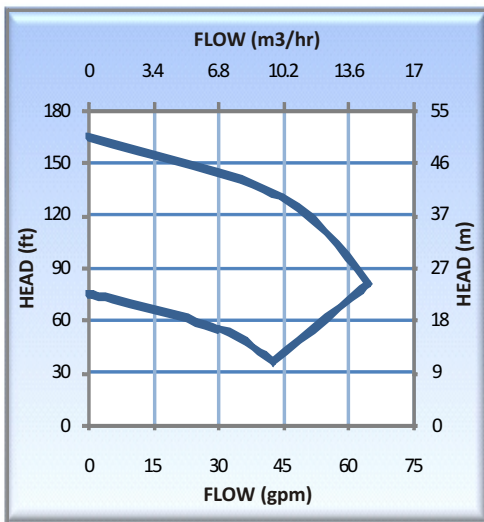

## MODELS

HP75MDSS: 3/4" x 3/4" x 6"

HP100MDSS: 1" x 1" x 6"

## FEATURES

- Low flow/high head pump
- Closed Impeller
- Maximum impeller diameter: 6.00"



## STANDARD SPECIFICATIONS

- Materials of construction : 316SS
- Standard NEMA C-Face motors
- Interchangeable front and rear bushings and washers

## OPERATING LIMITS

- Temperatures from Cryogenic to 350F
- Working pressures to 300 psi

## APPLICATIONS

- Refrigeration
- Chemical processes
- Semi-Conductor
- Biodiesel Production
- Water Treatment
- Pharmaceutical
- Cryogenic
- Galvanic Processes
- Pulp and Paper
- Automotive
- Vapor Degreasers
- Toxic Fluids
- Scrubber Applications
- Agriculture

# Type CD-MD

 **Flows to 160 GPM / Heads to 90 Feet**

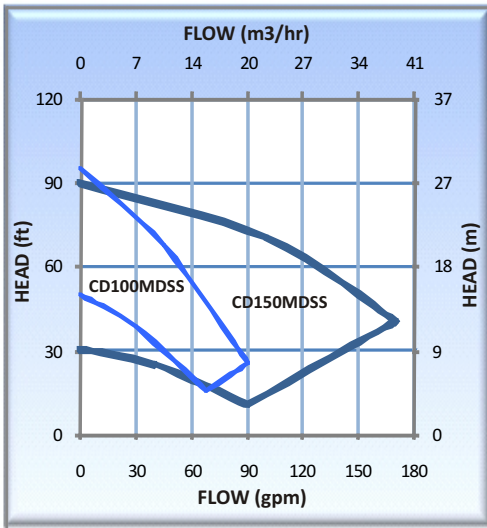

## FEATURES

- Mid-range compact pump
- Semi-open Impeller
- Maximum impeller diameter: 4.94"

## MODELS

**CD100MDSS: 1" x 1-1/4" x 5"**

**CD150MDSS: 1-1/2" x 2" x 5"**

# Type CL-MD

 **Flows to 320 GPM / Heads to 145 Feet**

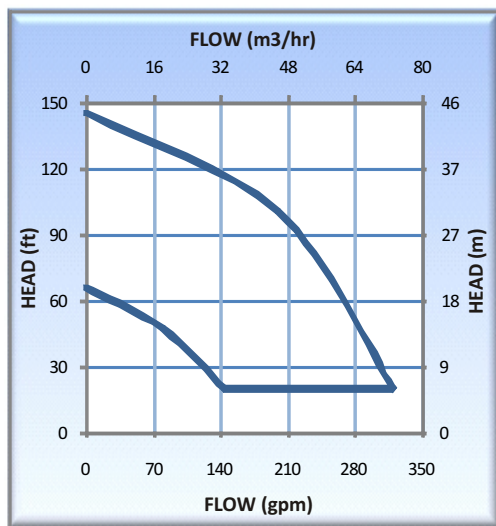

## FEATURES

- High flow/high efficiency pump
- Hex drive shaft option
- Semi-open Impeller
- Maximum impeller diameter: 5.76"

## MODELS

**CL150MDSS: 1-1/2" x 2" x 5-3/4"**

## STANDARD SPECIFICATIONS

- Materials of construction : 316SS
- Standard NEMA C-Face motors
- Interchangeable front and rear bushings and washers

## OPERATING LIMITS

- Temperatures from Cryogenic to 350F
- Working pressures to 300 psi

## APPLICATIONS

- Refrigeration
- Chemical processes
- Semi-Conductor
- Biodiesel Production
- Water Treatment
- Pharmaceutical
- Cryogenic
- Galvanic Processes
- Pulp and Paper
- Automotive
- Vapor Degreasers
- Toxic Fluids
- Scrubber Applications
- Agriculture

# Type XT-MD

 Flows to 400 GPM / Heads to 150 Feet

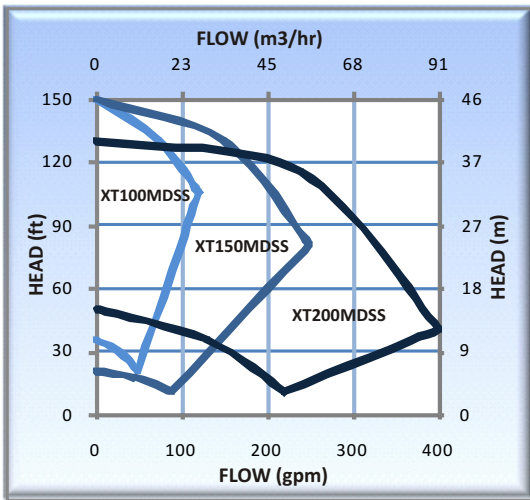

## FEATURES

- High flow/high head pump
- Hex drive shaft option
- Closed Impeller
- Maximum impeller diameter: 5.98"

## MODELS

- XT100MDSS: 1" x 1-1/2" x 6"
- XT150MDSS: 1-1/2" x 2" x 6"
- XT200MDSS: 2" x 3" x 6"

# Type XL-MD

 Flows to 400 GPM / Heads to 150 Feet

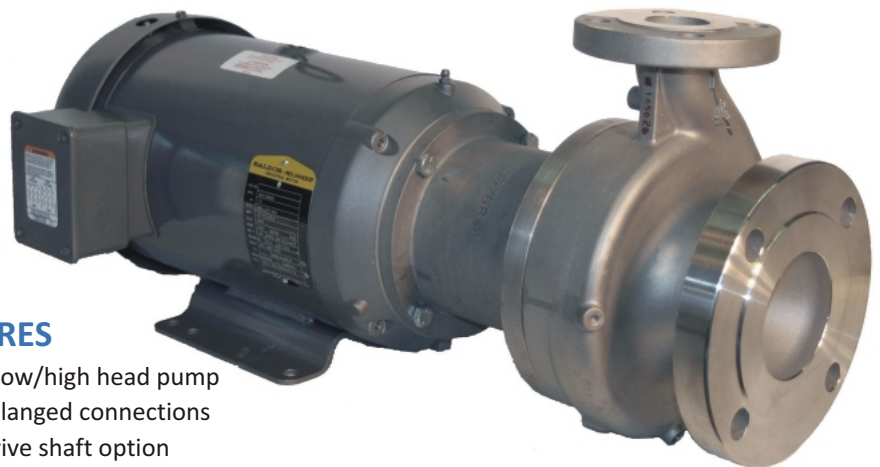
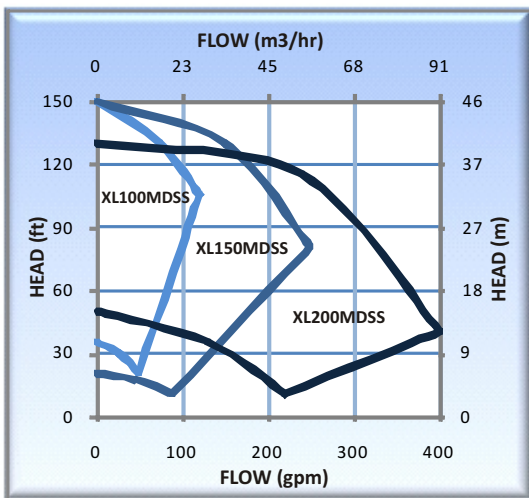

## FEATURES

- High flow/high head pump
- ANSI Flanged connections
- Hex drive shaft option
- Closed Impeller
- Maximum impeller diameter: 5.98"

## MODELS

- XL100MDSS: 1" x 1-1/2" x 6"
- XL150MDSS: 1-1/2" x 3" x 6"
- XL200MDSS: 2" x 3" x 6"

## STANDARD SPECIFICATIONS

- Materials of construction : 316SS
- Standard NEMA C-Face motors
- Interchangeable front and rear bushings and washers

## OPERATING LIMITS

- Temperatures from Cryogenic to 350F
- Working pressures to 300 psi

## APPLICATIONS

- Refrigeration
- Chemical processes
- Semi-Conductor
- Biodiesel Production
- Water Treatment
- Pharmaceutical
- Cryogenic
- Galvanic Processes
- Pulp and Paper
- Automotive
- Vapor Degreasers
- Toxic Fluids
- Scrubber Applications
- Agriculture

Mag-drive applications often require a soft starter, torque or speed control and full load amperage protection. Price® Pump is now offering variable frequency drives (VFDs) that offer precision control and fast response that exceeds the performance of conventional 'general-purpose' AC inverters. Offering multiple modes of motor control, our drives deliver accurate speed and torque control along with motor overload protection. Our drives are specifically designed to be easy to install and apply. With a standard 5-year warranty, quality and reliability is guaranteed.



### D700 Series:

The D700 series is an ultra compact, micro-drive and is designed to be very user friendly. Small, cost effective and reliable.

**D710W:** 1/8-1 HP, 1-Ph (110-115V) Input, 3-Ph (230V) Output

**D720S:** 1/8-3 HP, 1-Ph (200-240V) Input, 3-Ph (200-240V) Output

**D720:** 1/8-10 HP, 3-Ph (200-240V) Input, 3-Ph (200-240V) Output

**D740:** 1/2-10 HP, 3-Ph (380-480V) Input, 3-Ph (380-480V) Output

**Enclosure:** IP20



### E700 Series:

The E700 series is a compact drive with more features and capabilities than the D700. Versatile, reliable and expandable.

**E720:** 1/8-20 HP, 3-Ph (200-240V) Input, 3-Ph (200-240V) Output

**E740:** 1/2-20 HP, 3-Ph (380-480V) Input, 3-Ph (380-480V) Output

**Enclosure:** IP20

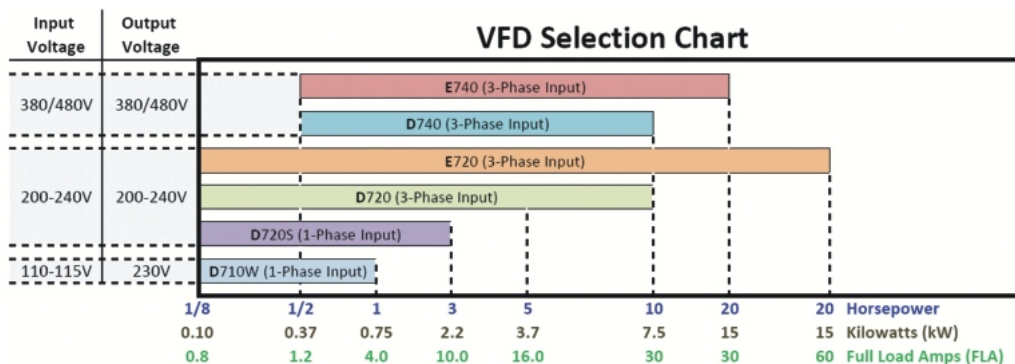

# Price<sup>®</sup> Pump is known for its versatile line of centrifugal pumps and the shortest lead-times in the pump industry!



**Price<sup>®</sup> Pump** specializes in rapid delivery of both custom and standard centrifugal sealed, seal-less and air-operated diaphragm pumps. All pump models listed in our price sheets are shipped within our standard lead time of 7-10 working days. Expedited, next and same day shipments, are available lead-time options when you need a pump sooner than later.

At **Price<sup>®</sup> Pump**, we back our products with a 2-year warranty along with prompt and efficient service you expect from a leading pump supplier.

Our expert technical support personnel provide timely and accurate information on the performance and availability of every Price Pump. We can help you select the right pump for a unique application and often suggest alternatives that may improve pump performance and save you money. Pump modifications and expedited deliveries are our specialty.

**Price<sup>®</sup> Pump** supplies both centrifugal and air-operated diaphragm (AOD<sup>®</sup>) pumps for O.E.M., Agricultural, chemical, laser, Biodiesel semiconductor, pollution control, waste and water treatment, and many other industrial applications. Our pumps are suitable for liquids ranging from water, oils, solvents and chemicals to strong acid or alkaline solutions.

The next time you need a reliable centrifugal or AOD<sup>®</sup> pump - **THINK QUALITY, THINK DELIVERY, THINK PRICE<sup>®</sup>!**

Distributed by

**Deutschland Österreich**  
VIPTech GmbH  
Lessingstrasse 22  
D-72663 Großbettingen  
Tel: +49 07022 948 735  
Fax: +49 07022 948 636  
mail: [anfrage@price-pumpen.de](mailto:anfrage@price-pumpen.de)  
web: [www.price-pumpen.de](http://www.price-pumpen.de)



**21775 Eighth St. East  
Sonoma, CA 95476-0329**

**Toll Free: (800) 345-7867  
Main: (707) 938-8441  
Fax: (707) 938-0764  
Email: [sales@pricepump.com](mailto:sales@pricepump.com)  
[www.pricepump.com](http://www.pricepump.com)**

